

SAXONIA

Edelstahltechnik und -handels GmbH

Salzburger Strasse 38 - 40

01279 Dresden

Tel.: 0351 2542831

Fax.: 0351 2542833

e-Mail: service@saxonia-edelstahl.de

www.saxonia-edelstahl.de



Gewindefittings

Inhalt

	Seite
Muffe	3
Halbe Muffe	3
Rohnippel DIN 2982	3
Sonderlängen auf Anfrage	4
Gewindekrümmer 90°	4
Gewindekrümmer 45°	4
Doppelnippel DIN 2982	5
Sechskantdoppelnippel DIN 2990	5
Winkel 90°	5
Winkel 45°	6
Winkel 90° mit Innen-/Außengewinde	6
T-Stück	6
Kreuz-Stück	7
Reduzierstück	7
Reduziernippel	8
Reduziermuffe	9
Muffennippel	10
6-kant Stopfen	10
4-kant Stopfen	11
Verschlußstopfen DIN 910	11
6-kant Kappe	11
Sechskantmutter DIN 431	12
Schlauchtülle	12
Schweißschlauchtülle	13
Gewindeschlauchtülle	13
Verschraubung, Innengewinde	14
Verschraubung, Innen- / Außengewinde	14
Verschraubung, Außengewinde	15
Verschraubung, Innengewinde/Außengewinde	15
Verschraubung Außengewinde/Anschweißende	16
Schweißverschraubung	16
Verschraubung, Innengew. / Schlauchanschl.	17
Verschraubung Schweißende/Schlauchanschl.	17
Verschraubung, Außengewinde/Schlauchanschl.	17

Muffe

Werkstoff: 1.4541/1.4571

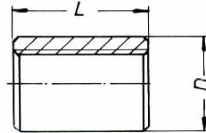
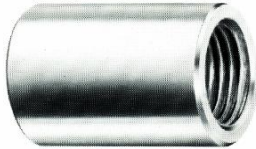

Zoll	L	D	Artikelnummer
1/8"	17	14	MU - 018 - 000 - 4
1/4"	25	18,5	MU - 014 - 000 - 4
3/8"	26	21,3	MU - 038 - 000 - 4
1/2"	34	26,4	MU - 012 - 000 - 4
3/4"	36	31,8	MU - 034 - 000 - 4
1"	43	39,5	MU - 100 - 000 - 4
1 1/4"	48	48,3	MU - 114 - 000 - 4
1 1/2"	48	54,5	MU - 112 - 000 - 4
2"	56	66,3	MU - 200 - 000 - 4
2 1/2"	65	82	MU - 212 - 000 - 4
3"	71	95	MU - 300 - 000 - 4
4"	83	122	MU - 400 - 000 - 4

Halbe Muffe

Werkstoff: 1.4541/1.4571

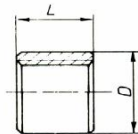

Zoll	L	D	Artikelnummer
1/8"	10	14,5	HM - 018 - 000 - 4
1/4"	10	17,5	HM - 014 - 000 - 4
3/8"	12	21,5	HM - 038 - 000 - 4
1/2"	15	27	HM - 012 - 000 - 4
3/4"	17	33,5	HM - 034 - 000 - 4
1"	20	40	HM - 100 - 000 - 4
1 1/4"	20	50	HM - 114 - 000 - 4
1 1/2"	21	57	HM - 112 - 000 - 4
2"	27	70	HM - 200 - 000 - 4
2 1/2"	30	86	HM - 212 - 000 - 4
3"	33	100	HM - 300 - 000 - 4
4"	40	126	HM - 400 - 000 - 4

Rohrrippe DIN 2982

mit zylindrischem Gewinde

Werkstoff: 1.4571

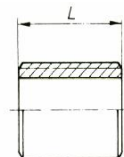

Zoll	L	D	Artikelnummer
1/8"	16		NI - 018 - 000 - 4
1/4"	18		NI - 014 - 000 - 4
3/8"	22		NI - 038 - 000 - 4
1/2"	25		NI - 012 - 000 - 4
3/4"	30		NI - 034 - 000 - 4
1"	35		NI - 100 - 000 - 4
1 1/4"	38		NI - 114 - 000 - 4
1 1/2"	38		NI - 112 - 000 - 4
2"	45		NI - 200 - 000 - 4
2 1/2"	55		NI - 212 - 000 - 4
3"	60		NI - 300 - 000 - 4
4"	70		NI - 400 - 000 - 4

Sonderlängen auf Anfrage

Anschweißnipel DIN 2981

Werkstoff: 1.4541/1.4571

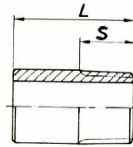

Zoll	L	S	Artikelnummer
1/8"	30	8	AN - 018 - 000 - 4
1/4"	30	11	AN - 014 - 000 - 4
3/8"	35	12	AN - 038 - 000 - 4
1/2"	40	15	AN - 012 - 000 - 4
3/4"	40	17	AN - 034 - 000 - 4
1"	40	20	AN - 100 - 000 - 4
1 1/4"	50	22	AN - 114 - 000 - 4
1 1/2"	50	22	AN - 112 - 000 - 4
2"	50	26	AN - 200 - 000 - 4
2 1/2"	60	32	AN - 212 - 000 - 4
3"	70	35	AN - 300 - 000 - 4
4"	80	42	AN - 400 - 000 - 4

Gewindekrümmer 90°

Werkstoff: 1.4571

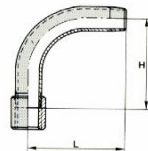

Zoll	L	H	Artikelnummer
1/8"	50	50	Artikel auf Anfrage
1/4"	60	60	
3/8"	70	70	
1/2"	80	80	
3/4"	100	100	
1"	120	120	
1 1/4"	140	140	
1 1/2"	160	160	
2"	190	190	
2 1/2"	240	240	
3"	290	290	

Gewindekrümmer 45°

Werkstoff: 1.4571

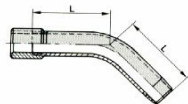

Zoll	L	H	Artikelnummer
1/8"	45		Artikel auf Anfrage
1/4"	50		
3/8"	60		
1/2"	65		
3/4"	85		
1"	100		
1 1/4"	115		
1 1/2"	135		
2"	160		
2 1/2"	200		
3"	240		

Doppelnippel DIN 2982

Werkstoff: 1.4541/1.4571

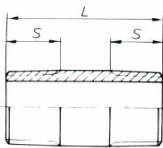

Zoll	40	60	80	100	120	150	200	S	Artikelnummer
1/8"	●	■	■	■	■	■	■	8	DN - 018 - Länge - 4
1/4"	●	▲	▲	▲	■	▲	■	11	DN - 014 - Länge - 4
3/8"	●	▲	■	▲	▲	▲	■	12	DN - 038 - Länge - 4
1/2"	▲	●	▲	▲	▲	▲	■	15	DN - 012 - Länge - 4
3/4"	▲	●	▲	▲	▲	▲	■	17	DN - 034 - Länge - 4
1"	▲	●	▲	▲	▲	▲	■	20	DN - 100 - Länge - 4
1 1/4"		▲	●	▲	▲	▲	■	22	DN - 114 - Länge - 4
1 1/2"		▲	●	▲	▲	▲	■	22	DN - 112 - Länge - 4
2"		▲	▲	●	▲	▲	■	26	DN - 200 - Länge - 4
2 1/2"			▲	●	▲	■	■	32	DN - 212 - Länge - 4
3"			■	●	▲	■	■	35	DN - 300 - Länge - 4
4"				■	●	■	■	42	DN - 400 - Länge - 4

- Standardlänge
- ▲ Sonderlänge
- lieferbar

Sechskantdoppelnippel DIN 2990

Werkstoff: V4A

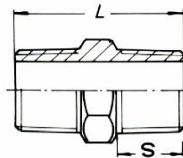

Zoll	L	S	SW	Artikelnummer
1/8"	22	8	12	DN - 018 - 6KT - G
1/4"	24	9	14	DN - 014 - 6KT - G
3/8"	28	11	19	DN - 038 - 6KT - G
1/2"	34	14	22	DN - 012 - 6KT - G
3/4"	40	16	27	DN - 034 - 6KT - G
1"	46	19	36	DN - 100 - 6KT - G
1 1/4"	52	21	46	DN - 114 - 6KT - G
1 1/2"	54	21	50	DN - 112 - 6KT - G
2"	62	24	65	DN - 200 - 6KT - G
2 1/2"	70	27	80	DN - 212 - 6KT - G
3"	82	33	95	DN - 300 - 6KT - G

Winkel 90°

Werkstoff: V4A

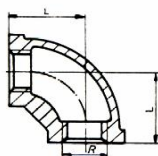

Zoll	L	Artikelnummer
1/4"	21	WI - 014 - 000 - G
3/8"	25	WI - 038 - 000 - G
1/2"	28	WI - 012 - 000 - G
3/4"	33	WI - 034 - 000 - G
1"	38	WI - 100 - 000 - G
1 1/4"	45	WI - 114 - 000 - G
1 1/2"	50	WI - 112 - 000 - G
2"	58	WI - 200 - 000 - G
2 1/2"	70	WI - 212 - 000 - G
3"	80	WI - 300 - 000 - G

Winkel 45°

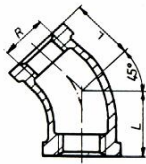

Werkstoff: V4A

Zoll	L	Artikelnummer
1/4"	19	WI - 014 - 045 - G
3/8"	20	WI - 038 - 045 - G
1/2"	23	WI - 012 - 045 - G
3/4"	25	WI - 034 - 045 - G
1"	29	WI - 100 - 045 - G
1 1/4"	33	WI - 114 - 045 - G
1 1/2"	37	WI - 112 - 045 - G
2"	43	WI - 200 - 045 - G

Winkel 90° mit Innen/Außengewinde

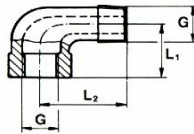

Werkstoff: V4A

Zoll	L1	L2	Artikelnummer
1/4"	21	28	WI - 014 - 0IA - G
3/8"	25,5	32	WI - 038 - 0IA - G
1/2"	27,5	37	WI - 012 - 0IA - G
3/4"	31	43	WI - 034 - 0IA - G
1"	37,5	52	WI - 100 - 0IA - G
1 1/4"	44	60	WI - 114 - 0IA - G
1 1/2"	50	65	WI - 112 - 0IA - G
2"	56	74	WI - 200 - 0IA - G

T-Stück

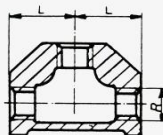
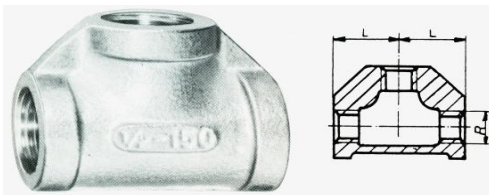

Werkstoff: V4A

Zoll	L	Artikelnummer
1/4"	21	TS - 014 - 000 - G
3/8"	25	TS - 038 - 000 - G
1/2"	28	TS - 012 - 000 - G
3/4"	33	TS - 034 - 000 - G
1"	38	TS - 100 - 000 - G
1 1/4"	45	TS - 114 - 000 - G
1 1/2"	50	TS - 112 - 000 - G
2"	58	TS - 200 - 000 - G
2 1/2"	70	TS - 212 - 000 - G
3"	80	TS - 300 - 000 - G

Auch mit reduziertem Abgang lieferbar!

Kreuz-Stück

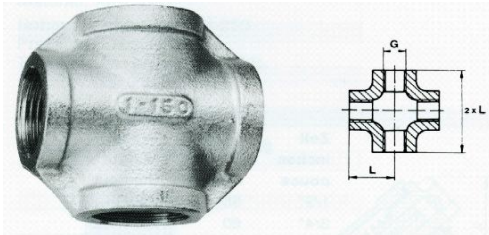

Werkstoff: V4A

Zoll	L	Artikelnummer
1/4"	20	KS - 014 - 000 - G
3/8"	24	KS - 038 - 000 - G
1/2"	28	KS - 012 - 000 - G
3/4"	33	KS - 034 - 000 - G
1"	38	KS - 100 - 000 - G
1 1/4"	45	KS - 114 - 000 - G
1 1/2"	49	KS - 112 - 000 - G
2"	57	KS - 200 - 000 - G

Reduzierstück

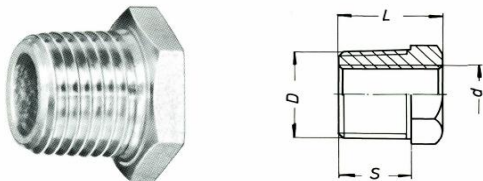

Werkstoff: V4A Gußausführung

auch lieferbar in gedrehter Ausführung Werkstoff 1.4571

Zoll	L	S	SW	Artikelnummer
1/4 x 1/8	17	13	17	RS - 014 - 018 - G
3/8 x 1/8	18	13	21	RS - 038 - 018 - G
3/8 x 1/4	18	13	21	RS - 038 - 014 - G
1/2 x 1/8	22	15	24	RS - 012 - 018 - G
1/2 x 1/4	20	14	22	RS - 012 - 014 - G
1/2 x 3/8	20	14	22	RS - 012 - 038 - G
3/4 x 1/4	24	18	32	RS - 034 - 014 - G
3/4 x 3/8	24	17	27	RS - 034 - 038 - G
3/4 x 1/2	24	17	27	RS - 034 - 012 - G
1 x 1/4	27	20	36	RS - 100 - 014 - G
1 x 3/8	27	19	36	RS - 100 - 038 - G
1 x 1/2	27	19	36	RS - 100 - 012 - G
1 x 3/4	27	19	36	RS - 100 - 034 - G
1 1/4 x 3/8	31	22	46	RS - 114 - 038 - G
1 1/4 x 1/2	31	22	46	RS - 114 - 012 - G
1 1/4 x 3/4	31	22	46	RS - 114 - 034 - G
1 1/4 x 1	31	22	46	RS - 114 - 100 - G
1 1/2 x 1/2	33	22	50	RS - 112 - 012 - G
1 1/2 x 3/4	33	22	50	RS - 112 - 034 - G
1 1/2 x 1	33	22	50	RS - 112 - 100 - G
1 1/2 x 1 1/4	33	22	50	RS - 112 - 114 - G
2 x 1	38	26	65	RS - 200 - 100 - G
2 x 1 1/4	38	26	65	RS - 200 - 114 - G
2 x 1 1/2	38	26	65	RS - 200 - 112 - G
2 1/2 x 1 1/4	43	30	80	RS - 212 - 114 - G
2 1/2 x 1 1/2	43	30	80	RS - 212 - 112 - G
2 1/2 x 2	43	30	80	RS - 212 - 200 - G
3 x 1 1/2	48	35	90	RS - 300 - 112 - G
3 x 2	48	35	90	RS - 300 - 200 - G
3 x 2 1/2	48	35	90	RS - 300 - 212 - G

Reduziernippel

Werkstoff: V4A Gußausführung

auch lieferbar in gedrehter Ausführung Werkstoff 1.4571

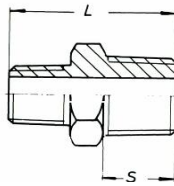
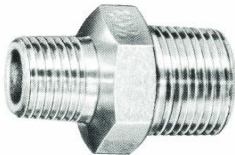

Zoll	L	S	SW	Artikelnummer
1/4 x 1/8	25	10	14	RN - 014 - 018 - G
3/8 x 1/8	29	11	19	RN - 038 - 018 - G
3/8 x 1/4	30	11	19	RN - 038 - 014 - G
1/2 x 1/8	33	14	22	RN - 012 - 018 - G
1/2 x 1/4	33	14	22	RN - 012 - 014 - G
1/2 x 3/8	33	14	22	RN - 012 - 038 - G
3/4 x 1/4	36	16	27	RN - 034 - 014 - G
3/4 x 3/8	37	16	27	RN - 034 - 038 - G
3/4 x 1/2	40	16	27	RN - 034 - 012 - G
1 x 1/4	39	18	36	RN - 100 - 014 - G
1 x 3/8	40	18	36	RN - 100 - 038 - G
1 x 1/2	43	18	36	RN - 100 - 012 - G
1 x 3/4	45	18	36	RN - 100 - 034 - G
1 1/4 x 1/2	47	21	46	RN - 114 - 012 - G
1 1/4 x 3/4	48	21	46	RN - 114 - 034 - G
1 1/4 x 1	50	21	46	RN - 114 - 100 - G
1 1/2 x 1/2	50	21	50	RN - 112 - 012 - G
1 1/2 x 3/4	52	21	50	RN - 112 - 034 - G
1 1/2 x 1	54	21	50	RN - 112 - 100 - G
1 1/2 x 1 1/4	55	21	50	RN - 112 - 114 - G
2 x 1	58	26	65	RN - 200 - 100 - G
2 x 1 1/4	60	26	65	RN - 200 - 114 - G
2 x 1 1/2	60	26	65	RN - 200 - 112 - G
2 1/2 x 1 1/4	65	30	80	RN - 212 - 114 - G
2 1/2 x 1 1/2	65	30	80	RN - 212 - 112 - G
2 1/2 x 2	69	30	80	RN - 212 - 200 - G
3 x 1 1/2	73	35	90	RN - 300 - 112 - G
3 x 2	74	35	90	RN - 300 - 200 - G
3 x 2 1/2	84	35	90	RN - 300 - 212 - G

Reduziermuffe

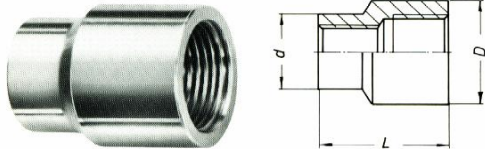

Werkstoff: V4A Gußausführung

Zoll	L	D	d	Artikelnummer
1/4 x 1/8	25	18	15	RM - 014 - 018 - G
3/8 x 1/4	30	22	18	RM - 038 - 014 - G
1/2 x 1/4	34	30	20	RM - 012 - 014 - G
1/2 x 3/8	34	30	25	RM - 012 - 038 - G
3/4 x 3/8	36	35	25	RM - 034 - 038 - G
3/4 x 1/2	36	35	30	RM - 034 - 012 - G
1 x 3/8	44	40	25	RM - 100 - 038 - G
1 x 1/2	44	40	30	RM - 100 - 012 - G
1 x 3/4	44	40	35	RM - 100 - 034 - G
1 1/4 x 1/2	50	50	30	RM - 114 - 012 - G
1 1/4 x 3/4	50	50	35	RM - 114 - 034 - G
1 1/4 x 1	50	50	40	RM - 114 - 100 - G
1 1/2 x 3/4	52	55	35	RM - 112 - 034 - G
1 1/2 x 1	52	55	40	RM - 112 - 100 - G
1 1/2 x 1 1/4	52	55	50	RM - 112 - 114 - G
2 x 1	58	70	40	RM - 200 - 100 - G
2 x 1 1/4	58	70	50	RM - 200 - 114 - G
2 x 1 1/2	58	70	60	RM - 200 - 112 - G
2 1/2 x 1 1/4	65	85	50	RM - 212 - 114 - G
2 1/2 x 1 1/2	65	85	60	RM - 212 - 112 - G
2 1/2 x 2	65	85	70	RM - 212 - 200 - G
3 x 2	70	100	70	RM - 300 - 200 - G

Muffennippel

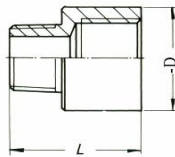
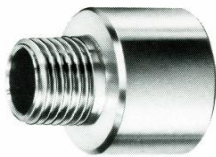

Werkstoff: V4A

Zoll	L	D	Artikelnummer
1/4 x 1/8	28	18	MN - 014 - 018 - 4
3/8 x 1/4	30	22	MN - 038 - 014 - 4
1/2 x 1/4	32	30	MN - 012 - 014 - 4
1/2 x 3/8	32	30	MN - 012 - 038 - 4
3/4 x 3/8	35	35	MN - 034 - 038 - 4
3/4 x 1/2	37	35	MN - 034 - 012 - 4
1 x 3/8	40	40	MN - 100 - 038 - 4
1 x 1/2	42	40	MN - 100 - 012 - 4
1 x 3/4	45	40	MN - 100 - 034 - 4
1 1/4 x 1/2	48	50	MN - 114 - 012 - 4
1 1/4 x 3/4	48	50	MN - 114 - 034 - 4
1 1/4 x 1	50	50	MN - 114 - 100 - 4
1 1/2 x 3/4	50	55	MN - 112 - 034 - 4
1 1/2 x 1	52	55	MN - 112 - 100 - 4
1 1/2 x 1 1/4	54	55	MN - 112 - 114 - 4
2 x 1	56	70	MN - 200 - 100 - 4
2 x 1 1/4	56	70	MN - 200 - 114 - 4
2 x 1 1/2	58	70	MN - 200 - 112 - 4
2 1/2 x 1 1/4	60	85	MN - 212 - 114 - 4
2 1/2 x 1 1/2	60	85	MN - 212 - 112 - 4
2 1/2 x 2	65	85	MN - 212 - 200 - 4
3 x 2	68	100	MN - 300 - 200 - 4

6-kant Stopfen

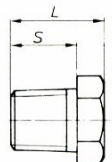
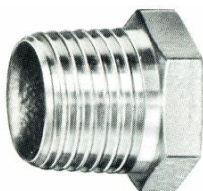

mit konischem Gewinde / Werkstoff: V4A Gußausführung

auch lieferbar in gedrehter Ausführung Werkstoff: 1.4571

Zoll	L	S	SW	Artikelnummer
1/8"	13	8	12	ST - 018 - 000 - G
1/4"	15	10	14	ST - 014 - 000 - G
3/8"	17	11	19	ST - 038 - 000 - G
1/2"	20	14	22	ST - 012 - 000 - G
3/4"	24	16	30	ST - 034 - 000 - G
1"	27	18	36	ST - 100 - 000 - G
1 1/4"	31	21	46	ST - 114 - 000 - G
1 1/2"	33	21	50	ST - 112 - 000 - G
2"	38	26	65	ST - 200 - 000 - G
2 1/2"	39	27	79	ST - 212 - 000 - G
3"	51	36	95	ST - 300 - 000 - G

4-kant Stopfen

mit konischem Gewinde / Werkstoff: V4A

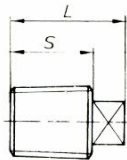
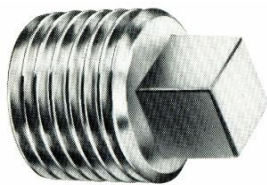

Zoll	L	S	SW	Artikelnummer
1/8"	12,5	8	7	ST - 018 - 4KT - G
1/4"	16	10	9	ST - 014 - 4KT - G
3/8"	19	11	10	ST - 038 - 4KT - G
1/2"	23	14	11	ST - 012 - 4KT - G
3/4"	27	11	17	ST - 034 - 4KT - G
1"	32	20	19	ST - 100 - 4KT - G
1 1/4"	35	21	22	ST - 114 - 4KT - G
1 1/2"	36	22	22	ST - 112 - 4KT - G
2"	43	27	27	ST - 200 - 4KT - G
2 1/2"	50	30	32	ST - 212 - 4KT - G
3"	57	37	36	ST - 300 - 4KT - G
4"	67	47	41	ST - 400 - 4KT - G

Verschlussstopfen DIN 910

mit zylindr. Gewinde / Werkstoff: V4A

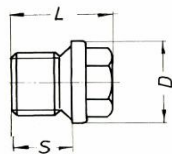
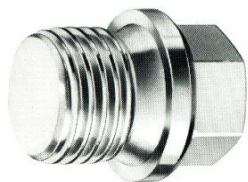

Zoll	D	S	SW	Artikelnummer
1/8"	14	11	11	ST - 018 - 910 - 4
1/4"	18	14	14	ST - 014 - 910 - 4
3/8"	22	17	17	ST - 038 - 910 - 4
1/2"	26	19	19	ST - 012 - 910 - 4
3/4"	32	24	24	ST - 034 - 910 - 4
1"	39	27	27	ST - 100 - 910 - 4
1 1/4"	49	30	30	ST - 114 - 910 - 4
1 1/2"	55	30	30	ST - 112 - 910 - 4
2"	68	36	36	ST - 200 - 910 - 4
2 1/2"	85	41	41	ST - 212 - 910 - 4
3"	95	46	46	ST - 300 - 910 - 4

6-kant Kappe

Werkstoff: V4A Gußausführung

auch lieferbar in gedrehter Ausführung Werkstoff: 1.4571

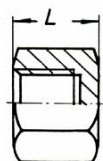

Zoll	L	SW	Artikelnummer
1/8"	13	14	KA - 018 - 000 - G
1/4"	15	17	KA - 014 - 000 - G
3/8"	17	22	KA - 038 - 000 - G
1/2"	20	27	KA - 012 - 000 - G
3/4"	24	32	KA - 034 - 000 - G
1"	27	41	KA - 100 - 000 - G
1 1/4"	32	50	KA - 114 - 000 - G
1 1/2"	32	55	KA - 112 - 000 - G
2"	34	70	KA - 200 - 000 - G
2 1/2"	36	85	KA - 212 - 000 - G
3"	38	105	KA - 300 - 000 - G

Sechskantmutter DIN 431

Werkstoff: V4A

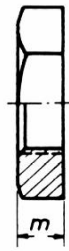
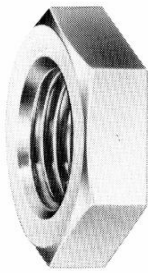

Zoll	L	SW	Artikelnummer
1/8"	6	19	MT - 018 - 000 - G
1/4"	6	22	MT - 014 - 000 - G
3/8"	7	27	MT - 038 - 000 - G
1/2"	8	32	MT - 012 - 000 - G
3/4"	9	36	MT - 034 - 000 - G
1"	10	46	MT - 100 - 000 - G
1 1/4"	11	55	MT - 114 - 000 - G
1 1/2"	12	60	MT - 112 - 000 - G
2"	13	75	MT - 200 - 000 - G
2 1/2"	16	95	MT - 212 - 000 - G
3"	19	105	MT - 300 - 000 - G
4"	22	135	MT - 400 - 000 - G

Schlauchtülle

Material: V4A

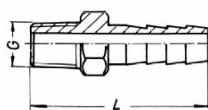
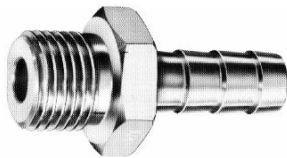

Außengewinde (SW1)

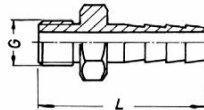

Außengewinde (SW2)

Zoll	Lichte Schlauchweite	SW1	SW2	L	Artikelnummer
1/4"	4	14	17	35	TÜ - 014 - 004 - G
1/4"	6	14	17	40	TÜ - 014 - 006 - G
1/4"	9	14	17	40	TÜ - 014 - 009 - G
3/8"	6	19	22	42	TÜ - 038 - 006 - G
3/8"	9	19	22	42	TÜ - 038 - 009 - G
3/8"	13	19	22	45	TÜ - 038 - 013 - G
1/2"	6	22	27	45	TÜ - 012 - 006 - G
1/2"	9	22	27	45	TÜ - 012 - 009 - G
1/2"	13	22	27	50	TÜ - 012 - 013 - G
3/4"	9	27	32	50	TÜ - 034 - 009 - G
3/4"	13	27	32	52	TÜ - 034 - 013 - G
3/4"	16	27	32	55	TÜ - 034 - 016 - G
1"	16	36	41	60	TÜ - 100 - 016 - G
1"	19	36	41	65	TÜ - 100 - 019 - G
1"	25	36	41	70	TÜ - 100 - 025 - G
1 1/4"	19	46	50	70	TÜ - 114 - 019 - G
1 1/4"	25	46	50	75	TÜ - 114 - 025 - G
1 1/4"	30	46	50	80	TÜ - 114 - 030 - G
1 1/2"	25	50	55	80	TÜ - 112 - 025 - G
1 1/2"	30	50	55	85	TÜ - 112 - 030 - G
1 1/2"	38	50	55	90	TÜ - 112 - 038 - G

Schweißschlauchtülle

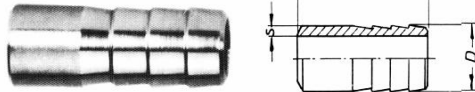

Werkstoff: V4A

lichte Schlauchweite	D	L	S	Artikelnummer
4	4,3	26	2	SN - 004 - 000 - 4
6	6,3	30	2	SN - 006 - 000 - 4
9	9,4	36	2	SN - 009 - 000 - 4
10	10,4	38	2	SN - 010 - 000 - 4
13	13,4	40	2,3	SN - 013 - 000 - 4
16	16,5	45	2,3	SN - 016 - 000 - 4
19	19,5	45	2,5	SN - 019 - 000 - 4
25	25,5	55	2,8	SN - 025 - 000 - 4
30	30,6	55	3,5	SN - 030 - 000 - 4
38	38,6	60	4	SN - 038 - 000 - 4

Gewindeschlauchtülle



Werkstoff: V4A

R	D	L	Artikelnummer
1/4"	13,5	70	GN - 014 - 000 - 4
3/8"	17,2	70	GN - 038 - 000 - 4
1/2"	21,3	70	GN - 012 - 000 - 4
3/4"	26,9	70	GN - 034 - 000 - 4
1"	33,7	70	GN - 100 - 000 - 4
1 1/4"	42,4	70	GN - 114 - 000 - 4
1 1/2"	48,3	100	GN - 112 - 000 - 4
2"	60,3	100	GN - 200 - 000 - 4

Verschraubung, Innengewinde

Werkstoff: V4A

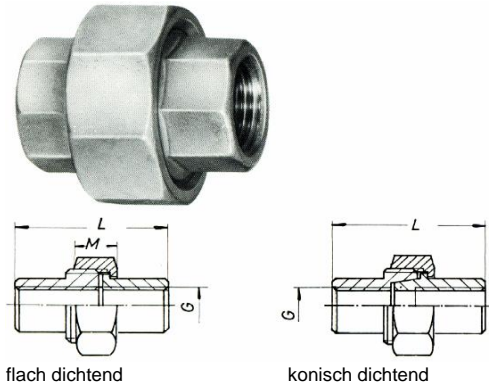

flach dichtend

konisch dichtend

Zoll	L	M	SW	Artikelnummer
1/4"	43	15	27	VK - 014 - 0II - G
3/8"	48	16	32	VK - 038 - 0II - G
1/2"	55	18	41	VK - 012 - 0II - G
3/4"	65	20	50	VK - 034 - 0II - G
1"	66	22	55	VK - 100 - 0II - G
1 1/4"	73	24	70	VK - 114 - 0II - G
1 1/2"	77	25	75	VK - 112 - 0II - G
2"	87	27	90	VK - 200 - 0II - G
2 1/2"	93	30	110	VK - 212 - 0II - G
3"	105	31	130	VK - 300 - 0II - G
4"	113	34	155	VK - 400 - 0II - G

Gußausführung

auch lieferbar in gedrehter Ausführung

Werkstoff: 1.4571

VK = konisch dichtend

VF = flach dichtend

Verschraubung, Innen- / Außengewinde

Werkstoff: V4A

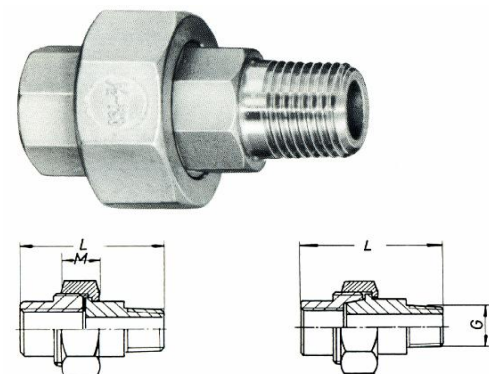

flach dichtend

konisch dichtend

Zoll	L	M	SW	Artikelnummer
1/4"	50	15	27	VK - 014 - 0IA - G
3/8"	55	16	32	VK - 038 - 0IA - G
1/2"	63	18	41	VK - 012 - 0IA - G
3/4"	71	20	50	VK - 034 - 0IA - G
1"	78	22	55	VK - 100 - 0IA - G
1 1/4"	94	24	70	VK - 114 - 0IA - G
1 1/2"	102	25	75	VK - 112 - 0IA - G
2"	107	27	90	VK - 200 - 0IA - G
2 1/2"	110	30	110	VK - 212 - 0IA - G
3"	122	31	130	VK - 300 - 0IA - G
4"	135	34	155	VK - 400 - 0IA - G

Gußausführung

auch lieferbar in gedrehter Ausführung

Werkstoff: 1.4571

VK = konisch dichtend

VF = flach dichtend

Verschraubung, Außengewinde

flach oder konisch dichtend

Werkstoff: V4A

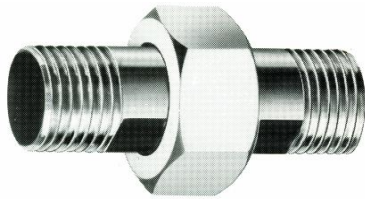

Zoll	L	M	SW	Artikelnummer
1/4"	57	15	27	VK - 014 - 0AA - G
3/8"	62	16	32	VK - 038 - 0AA - G
1/2"	71	18	41	VK - 012 - 0AA - G
3/4"	80	20	50	VK - 034 - 0AA - G
1"	90	22	55	VK - 100 - 0AA - G
1 1/4"	105	24	70	VK - 114 - 0AA - G
1 1/2"	112	25	75	VK - 112 - 0AA - G
2"	120	27	90	VK - 200 - 0AA - G
2 1/2"	130	30	110	VK - 212 - 0AA - G
3"	137	31	130	VK - 300 - 0AA - G
4"	140	34	155	VK - 400 - 0AA - G

VK = konisch dichtend
VF = flach dichtend

Verschraubung, Innengewinde/Außengewinde

flach oder konisch dichtend

Werkstoff: V4A

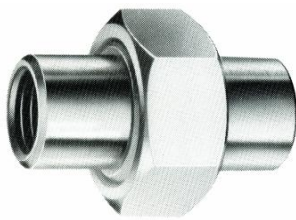

Zoll	D	L	SW	Artikelnummer
1/4"	13,5	45	27	VK - 014 - 0IS - G
3/8"	17,2	50	32	VK - 038 - 0IS - G
1/2"	21,3	55	41	VK - 012 - 0IS - G
3/4"	26,9	65	50	VK - 034 - 0IS - G
1"	33,7	66	55	VK - 100 - 0IS - G
1 1/4"	42,4	73	70	VK - 114 - 0IS - G
1 1/2"	48,3	77	75	VK - 112 - 0IS - G
2"	60,3	87	90	VK - 200 - 0IS - G
2 1/2"	76,1	93	110	VK - 212 - 0IS - G
3"	88,9	105	130	VK - 300 - 0IS - G
4"	114,3	113	155	VK - 400 - 0IS - G

VK = konisch dichtend
VF = flach dichtend

Verschraubung Außengewinde/Anschweißende

flach oder konisch dichtend

Werkstoff: V4A

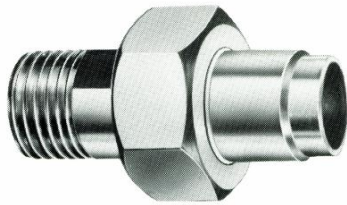

Zoll	D	L	SW	Artikelnummer
1/4"	13,5	50	27	VK - 014 - 0AS - G
3/8"	17,2	55	32	VK - 038 - 0AS - G
1/2"	21,3	63	41	VK - 012 - 0AS - G
3/4"	26,9	71	50	VK - 034 - 0AS - G
1"	33,7	78	55	VK - 100 - 0AS - G
1 1/4"	42,4	94	70	VK - 114 - 0AS - G
1 1/2"	48,3	102	75	VK - 112 - 0AS - G
2"	60,3	107	90	VK - 200 - 0AS - G
2 1/2"	76,1	110	110	VK - 212 - 0AS - G
3"	88,9	122	130	VK - 300 - 0AS - G
4"	114,3	135	155	VK - 400 - 0AS - G

VK = konisch dichtend
VF = flach dichtend

Schweißverschraubung

flach oder konisch dichtend

Werkstoff: V4A

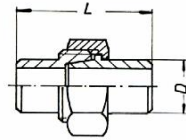
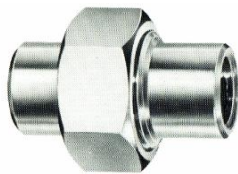

Zoll	D	L	SW	Artikelnummer
1/4"	13,5	40	27	VK - 014 - 0IA - G
3/8"	17,2	43	27	VK - 038 - 0IA - G
1/2"	21,3	48	32	VK - 012 - 0IA - G
3/4"	26,9	55	41	VK - 034 - 0IA - G
1"	33,7	65	50	VK - 100 - 0IA - G
1 1/4"	42,4	66	55	VK - 114 - 0IA - G
1 1/2"	48,3	73	70	VK - 112 - 0IA - G
2"	60,3	77	75	VK - 200 - 0IA - G
2 1/2"	76,1	87	80	VK - 212 - 0IA - G
3"	88,9	93	110	VK - 300 - 0IA - G
4"	114,3	105	130	VK - 400 - 0IA - G

VK = konisch dichtend
VF = flach dichtend

Verschraubung, Innengew. / Schlauchanschl.

flach (**VF**) oder konisch (**VK**) dichtend

Werkstoff: V4A

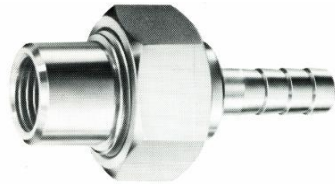

Zoll	D	SW	L	Artikelnummer
1/4"	6,4	27	59	Artikel auf Anfrage
3/8"	9,5	32	67	
1/2"	12,7	41	76	
3/4"	19,0	50	84	
1"	25,4	55	96	
1 1/4"	31,7	70	110	
1 1/2"	38,0	75	122	
2"	50,7	90	137	

Verschraubung Schweißende/Schlauchanschl.

flach (**VF**) oder konisch (**VK**) dichtend

Werkstoff: V4A

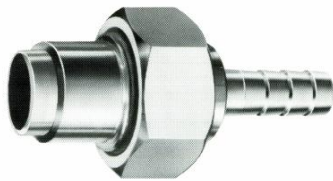

Zoll	D	SW	L	Artikelnummer
1/4"	6,4	27	59	Artikel auf Anfrage
3/8"	9,5	32	67	
1/2"	12,7	41	76	
3/4"	19,0	50	84	
1"	25,4	55	96	
1 1/4"	31,7	70	110	
1 1/2"	38,0	75	122	
2"	50,7	90	137	

Verschraubung, Außengewinde/Schlauchanschl.

flach (**VF**) oder konisch (**VK**) dichtend

Werkstoff: V4A

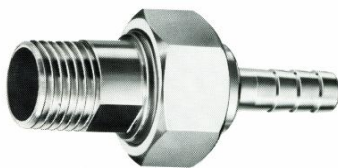

Zoll	D	SW	L	Artikelnummer
1/4"	6,4	27	66	Artikel auf Anfrage
3/8"	9,5	32	74	
1/2"	12,7	41	84	
3/4"	19,0	50	93	
1"	25,4	55	108	
1 1/4"	31,7	70	124	
1 1/2"	38,0	75	136	
2"	50,7	90	151	